

2MP VF Network IR Bullet Camera

IPC2322EBR5-DPZ28-C



Key Features

Optics

- Day/night functionality
- Smart IR, up to 50m (164 ft) IR distance
- Up to 120 dB Optical WDR (Wide Dynamic Range)
- 3D DNR (Digital Noise Reduction)

Compression

- H.265, H.264, MJPEG
- Embedded smart algorithm
- Triple streams
- ROI (Region of Interest)
- 9:16 corridor mode

Network

- ONVIF Conformance

Structure

- Support PoE power supply
- Wide temperature range: -35°C to 60°C (-31°F to 140°F)
- Wide voltage range of $\pm 25\%$
- IP67

Specifications

	IPC2322EBR5-DPZ28-C
Camera	
Sensor	1/2.9", 2 megapixel, progressive scan CMOS
Lens	2.8~12mm @F1.4
Angle of View(H)	94° ~28°
Zoom/Focus	Motor drive
Shutter	Auto/Manual, 1/6~1/100000 s
Min. Illumination	Colour: 0.02 Lux (F1.4, AGC ON) 0 Lux with IR on
IR Range	Up to 50m (164 ft) IR range
Day/Night	IR-cut filter with auto switch (ICR)
S/N	>52 dB
WDR	Optical WDR (up to 120 dB)
Video	
Max. Resolution	1920 × 1080
Video Compression	H.265, H.264, MJPEG
Frame Rate	1080P (1920*1080): Max. 30 fps; 720P (1280*720): Max. 30 fps; D1 (720*576): Max.8 fps
Video Streaming	Triple
9:16 Corridor Mode	Supported
ROI	Supported
HLC	Supported
Evaluative Metering	Supported
OSD	Up to 8 OSDs
Privacy Mask	Up to 8 areas
Smart	
Behavior Detection	Intrusion, crossing line, motion detection
Exception Detection	Audio detection
Intelligent Identification	Face detection, Defocus, Scene Change
Statistical Analysis	People counting
Audio	
Audio Compression	G.711
Two-way audio	Supported
Storage	
Edge Storage	Micro SD, up to 128 GB
Network	
Protocols	L2TP, IPv4, IGMP, ICMP, ARP, TCP, UDP, DHCP, PPPoE, RTP, RTSP, RTCP, DNS, DDNS, NTP, FTP, UPnP, HTTP, HTTPS, SMTP, 802.1x
Compatible Integration	ONVIF, API
Interface	
Audio I/O	Audio cable
	Input: impedance 35 kΩ; amplitude 2 V [p-p]
	Output: impedance 600 Ω; amplitude 2 V [p-p]

Alarm I/O	1 / 1
Network	10M/100M Base-TX Ethernet
General	
Power	12 V DC, or PoE (IEEE802.3 af)
	Power consumption: Max 11W
Dimensions (L × W × H)	253.4 × 86 × 71.7 mm (9.98" × 3.4" × 2.8")
Material	Cast aluminum
Weight	0.58kg (1.28lb)
Working Environment	-35°C ~ +60°C (-31°F ~ 140°F), Humidity ≤ 95% RH(non-condensing)
Ingress Protection	IP67

Dimensions

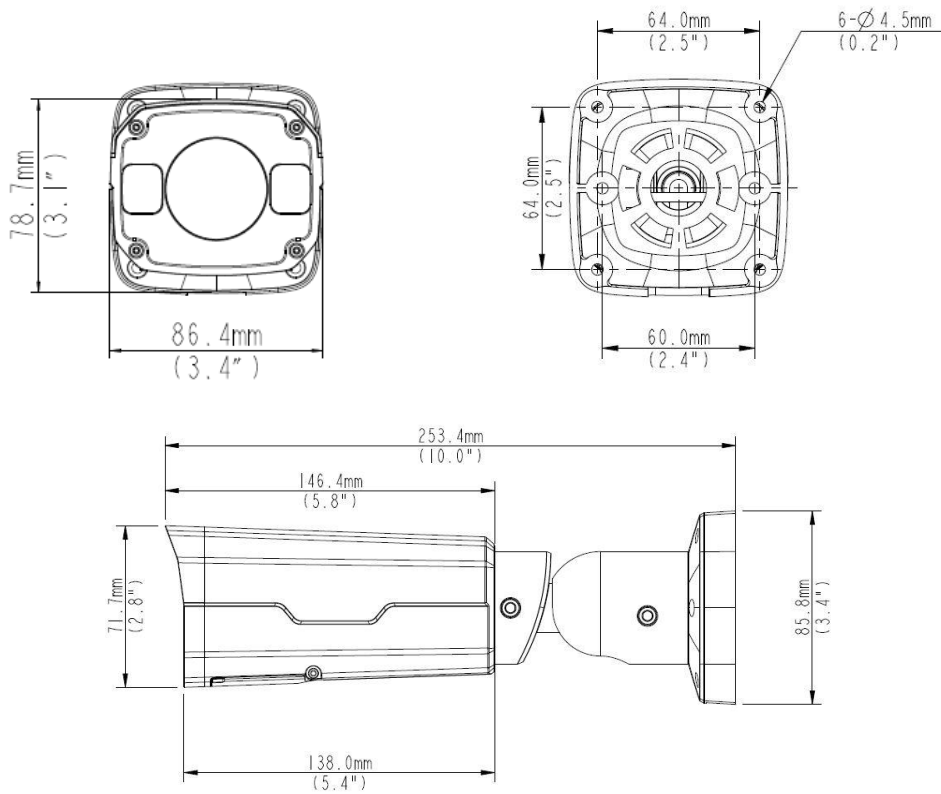

Accessories

Installation mode	Accessories	Description
Wall mount	\	Mounting pedestal is included in the Product package
Ceiling mount	\	Mounting pedestal is included in the Product package
Rail mount	TR-UP06-A-IN	For outdoor rail installation
Pole mount	TR-UP06-A-IN	For outdoor pole installation

Zhejiang Uniview Technologies Co., Ltd.

South Tower, Building 10, Wanlun Science Park, 88 Jiangling Road, Hangzhou, P.R.China 310051

Email: overseasbusiness@uniview.com; globalsupport@uniview.com

<http://www.uniview.com>

©2015-2017 Zhejiang Uniview Technologies Co., Ltd. All rights reserved.

*Product specifications and availability are subject to change without notice.