

DH-HAC-HFW2601E-A

6MP WDR HDCVI IR Bullet Camera

HDCVI



- 120dB True WDR, 3DNR
- Max. 6MP resolution
- HD/SD switchable
- Audio in interface, built-in mic
- 3.6mm fixed lens (2.8mm, 6mm optional)
- Max. IR length 40m, Smart IR
- IP67, DC12V±30%



System Overview

Experience 6 megapixel video with the simplicity of reusing existing coaxial infrastructure. The 6MP HDCVI camera presents a high quality image with rich details and accurate color rendition, and supports 120dB true WDR for a clear image in poor lighting conditions. The camera also features broadcast-quality audio to provide enhanced supplementary evidence collection. The higher resolution and complete set of features makes the 6MP HDCVI camera an ideal choice for mid to large-size businesses and projects where both highly reliable surveillance and construction flexibility are demanded.

Functions

4 Signals over 1 Coaxial Cable

HDCVI technology supports 4 signals to be transmitted over 1 coaxial cable simultaneously, i.e. video, audio*, data and power. Dual-way data transmission allows the HDCVI camera to interact with the HCVR, such as sending control signal or triggering alarm. Moreover, HDCVI technology supports PoC for construction flexibility.

* Audio input is available for some models of HDCVI cameras.

Long Distance Transmission

HDCVI technology guarantees real-time transmission at long distance without any loss. It supports up to 700m transmission for 4K and 4MP HD video via coaxial cable, and up to 300m via UTP cable.*

*Actual results verified by real-scene testing in Dahua's test laboratory.

Simplicity

HDCVI technology inherits the born feature of simplicity from traditional analog surveillance system, making itself a best choice for investment protection. HDCVI system can seamlessly upgrade the traditional analog system without replacing existing coaxial cabling. The plug and play approach enables full HD video surveillance without the hassle of configuring a network.

Broadcast-quality Audio

Audio information is used as supplementary evidence in video surveillance applications. The HDCVI camera supports audio signal transmission over coaxial cable. In addition, it adopts unique audio processing and transmission technology that best restores source audio and eliminates noise, guaranteeing the quality and effectiveness of collected audio information.

Multiple-formats

The camera supports multiple video formats including HDCVI, CVBS, and other two common HD analog formats in the market. A DIP switch located on the cable allows you to quickly toggle formats, further simplifying installation and debugging. This feature makes the camera compatible with not only XVRs, but also most existing HD/SD DVRs.

Smart IR

The camera is designed with array LED IR illumination for best lowlight performance. Smart IR is a technology to ensure brightness uniformity in B/W image under low illumination. Dahua's unique Smart IR adjusts to the intensity of camera's infrared LEDs to compensate for the distance of an object, and prevents IR LEDs from overexposing images as the object come closer to the camera.

Wide Dynamic Range

Embedded with industry leading wide dynamic range (WDR) technology, vivid pictures are achieved even in the most intense contrast lighting conditions. True WDR (120dB) optimizes both the bright and dark areas of a scene at the same time to provide usable video.

Advanced 3DNR

3DNR is noise reduction technology that detects and eliminates random noises by comparing two sequential frames. Dahua's advanced 3DNR technology allows remarkable noise reduction with little impact to sharpness, especially under limited lighting condition. Besides, the advanced 3DNR effectively decreases the band width and saves the storage space.

Protection

The camera's outstanding reliability is unsurpassed due to its rugged design. The camera is protected against water and dust with IP67 ranking, making it suitable for indoor or outdoor environments.

Supporting ±30% input voltage tolerance, this camera suits even the most unstable power supply conditions. Its 4KV lightning rating provides protection against the camera and its structure from the effects of lightning.

Technical Specification

Camera

Image Sensor	1/2.9" CMOS
Effective Pixels	3096(H)×2202(V), 6MP
Scanning System	Progressive
Electronic Shutter Speed	PAL: 1/4s~1/100,000s NTSC: 1/3s~1/100,000s
Minimum Illumination	0.01Lux/F1.9, 30IRE, 0Lux IR on
S/N Ratio	More than 65dB
IR Distance	Up to 40m (130feet)
IR On/Off Control	Auto / Manual
IR LEDs	2

Lens

Lens Type	Fixed lens / Fixed iris
Mount Type	Board-in
Focal Length	3.6mm (2.8mm, 6mm Optional)
Max Aperture	F1.9
Angle of View	H: 70° (89°/47°)
Focus Control	N/A
Close Focus Distance	1500mm (900mm, 3900mm) 59" (35.4", 153.5')

DORI Distance

Note: The DORI distance is a "general proximity" of distance which makes it easy to pinpoint the right camera for your needs. The DORI distance is calculated based on sensor specification and lab test result according to EN 62676-4 which defines the criteria for Detect, Observe, Recognize and Identify respectively.

	DORI Definition	Distance
Detect	25px/m (8px/ft)	2.8mm:69m(226ft) 3.6mm: 89m(292ft) 6mm:143m(469ft)
Observe	63px/m (19px/ft)	2.8mm:28m(92ft) 3.6mm:36m(118ft) 6mm:57m(187ft)
Recognize	125px/m (38px/ft)	2.8mm:14m(46ft) 3.6mm: 18m(59ft) 6mm: 29m(95ft)
Identify	250px/m (76px/ft)	2.8mm:7m(23ft) 3.6mm:9m(30ft) 6mm:14m(46ft)

Pan / Tilt / Rotation

Pan/Tilt/Rotation	Pan: 0° ~ 360° Tilt: 0° ~ 90° Rotation: 0° ~ 360°
-------------------	---

Video

Resolution	6MP (3096×2202)
Frame Rate	20fps@6MP, 25/30fps@4MP

Video Output	1-channel BNC high definition video output / CVBS video output (DIP switch)
Day/Night	Auto (ICR) / Manual
OSD Menu	Multi-language
BLC Mode	BLC / HLC / WDR
WDR	120dB
Gain Control	AGC
Noise Reduction	2D/3D
White Balance	Auto / Manual
Smart IR	Auto / Manual

Certifications

Certifications	CE (EN55032, EN55024, EN50130-4) FCC (CFR 47 FCC Part 15 subpartB, ANSI C63.4-2014) UL (UL60950-1+CAN/CSA C22.2 No.60950-1)
----------------	---

Interface

Audio Interface	1ch in & Built-in Mic
-----------------	-----------------------

Electrical

Power Supply	12V DC ±30%
Power Consumption	Max 6.8W (12V DC, IR on)

Environmental

Operating Conditions	-30°C ~ +60°C (-22°F ~ +140°F) / Less than 90% RH * Start up should be done at above-30°C (-22°F)
Storage Conditions	-30°C ~ +60°C (-22°F ~ +140°F) / Less than 90% RH
Ingress Protection & Vandal Resistance	IP67

Construction

Casing	Aluminium
Dimensions	179.9mm×70mm×70mm (7.08"×2.76"×2.76")
Net Weight	0.42kg (0.93lb)
Gross Weight	0.53kg (1.17lb)

Ordering Information

Type	Part Number	Description
6MP Camera	DH-HAC-HFW2604EP-A 2.8mm	6MP HDCVI WDR IR Bullet Camera, PAL
	DH-HAC-HFW2601EP-A 3.6mm	
	DH-HAC-HFW2601EP-A 6mm	
	DH-HAC-HFW2601EN-A 2.8mm	6MP HDCVI WDR IR Bullet Camera, NTSC
	DH-HAC-HFW2601EN-A 3.6mm	
	DH-HAC-HFW2601EN-A 6mm	
Accessories	PFA121	Junction box (For use alone or with PFA152-E pole mount)
	PFA152-E	Pole mount (For use with PFA121 junction box)
	PFM800-E	Passive HDCVI Balun
	PFM321	12V 1A Power Adapter
	PFM320	12V 2A Power Adapter
	PFM320D-015	12V 1.5A Power Adapter

Accessories

Optional:



PFA121
Junction box



PFA152-E
Pole mount



PFM321
12V 1A Power Adapter



PFM320
12V 2A Power Adapter



PFM800-E
Passive HDCVI Balun



PFM320D-015
Power Adapter

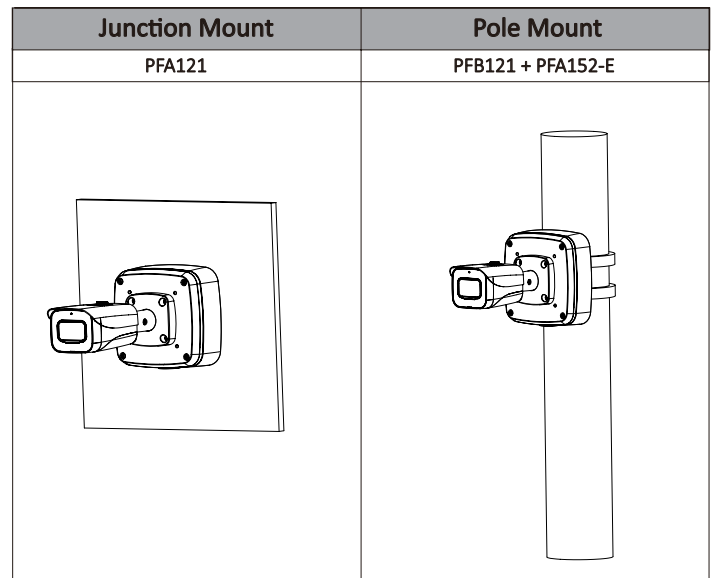

Dimensions (mm/inch)

