

## DS-2DF5225X-AEL(3) 2MP 25× Network Speed Dome

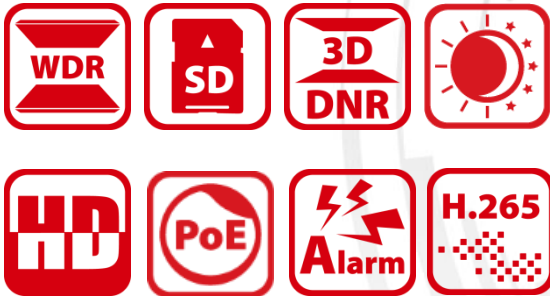

Hikvision DS-2DF5225X-AEL(3) 2MP 25× Network Speed Dome adopts 1/2.8" progressive scan CMOS chip. With the 25× optical zoom lens, the camera offers more details over expansive areas.

This series of cameras can be widely used for wide ranges of high-definition, such as the rivers, forests, roads, railways, airports, ports, squares, parks, scenic spots, stations and large venues, etc.



### Key Features

- 1/2.8" progressive scan CMOS
- Up to 1920 × 1080 resolution
- Min. Illumination:  
Color: 0.05 Lux @(F1.6, AGC ON)  
B/W: 0.01 Lux @(F1.6, AGC ON)
- 25× optical zoom, 16× digital zoom
- 120dB WDR, 3D DNR, HLC
- 24 VAC & Hi-PoE
- Support H.265+/H.265 video compression



## Specification

<b>Camera Module</b>	
<b>DS-2DF5225X-AEL(3) 2MP 25× Network Speed Dome</b>	
Image Sensor	1/2.8" progressive scan CMOS
Min. Illumination	Color: 0.05 Lux @(F1.6, AGC ON) B/W: 0.01 Lux @(F1.6, AGC ON)
Shutter Time	1/1 s to 1/30,000 s
White Balance	Auto/Manual/ATW (Auto-tracking White Balance)/Indoor/Outdoor/Fluorescent Lamp/Sodium Lamp
AGC	Auto/Manual
Day & Night	IR cut filter
Digital Zoom	16×
Privacy Mask	24 programmable privacy masks
Focus Mode	Auto/Semi-automatic/Manual
3D DNR	Support
BLC	Support
HLC	Support
WDR	120dB
Defog	Support
EIS	Support
Regional Exposure	Support
Regional Focus	Support
<b>Lens</b>	
Focal Length	4.5 mm to 112.5 mm, 25× Optical
Zoom Speed	Approx. 3.7 s (optical lens, wide-tele)
Field of View	Horizontal field of view: 61.4° to 2.7° (wide-tele) Vertical field of view: 40.7° to 1.7° (wide-tele) Diagonal field of view: 70.0° to 3.2° (wide-tele)
Working Distance	10 mm to 1500 mm (wide-tele)
Aperture Range	F1.6 to F4.0
<b>PTZ</b>	
Movement Range (Pan)	360° endless
Pan Speed	Configurable, from 0.1°/s to 300°/s, Preset Speed: 540°/s
Movement Range (Tilt)	From -5° to 90°
Tilt Speed	Configurable, from 0.1°/s to 240°/s, Preset Speed: 400°/s
Proportional Zoom	Support
Presets	300
Patrol Scan	8 patrols, up to 32 presets for each patrol
Pattern Scan	4 pattern scans, record time over 10 minutes for each scan
Power-off Memory:	Support
Park Action	Preset/Pattern Scan/Patrol Scan/Auto Scan/Tilt Scan/Random Scan/Frame Scan/Panorama Scan
PTZ Status Display	Support
Preset Freezing	Support
Scheduled Task	Preset/Pattern Scan/Patrol Scan/Auto Scan/Tilt Scan/Random Scan/Frame Scan/Panorama Scan/Dome Reboot/Dome Adjust/Aux Output
<b>Smart Features</b>	
Smart Detection	Intrusion Detection, Line Crossing Detection, Region Entrance Detection, Region Exiting Detection, Face Detection, Audio Exception Detection
Smart Tracking	Manual Tracking, Auto Tracking, Event Tracking
Smart Record	ANR (Automatic Network Replenishment), Dual-VCA

Network	
Max. Resolution	1920 × 1080
Main Stream	50Hz: 25fps (1920 × 1080, 1280 × 960, 1280 × 720) 50fps (1920 × 1080, 1280 × 960, 1280 × 720) 60Hz: 30fps (1920 × 1080, 1280 × 960, 1280 × 720) 60fps (1920 × 1080, 1280 × 960, 1280 × 720)
Sub-Stream	50Hz: 25fps (704 × 576, 640 × 480, 352 × 288) 60Hz: 30fps (704 × 480, 640 × 480, 352 × 240)
Third Stream	50Hz: 25fps (1920 × 1080, 1280 × 960, 1280 × 720, 704 × 576, 640 × 480, 352 × 288) 60Hz: 30fps (1920 × 1080, 1280 × 960, 1280 × 720, 704 × 480, 640 × 480, 352 × 240)
ROI	Support
SVC	Support
Video Compression	Main Stream: H.265+/H.265/H.264+/H.264 Sub-Stream: H.265/H.264/MJPEG Third Stream: H.265/H.264/MJPEG H.264 with Baseline/Main/High Profile
Audio compression	G.711alaw/G.711ulaw/G.722.1/G.726/MP2L2/PCM
Protocols	IPv4/IPv6, HTTP, HTTPS, 802.1x, Qos, FTP, SMTP, UPnP, SNMP, DNS, DDNS, NTP, RTSP, RTP, TCP/IP, DHCP, PPPoE, Bonjour
Simultaneous Live View	Up to 20 channels
User/Host	Up to 32 users 3 levels: Administrator, Operator and User
Security Measures	User authentication (ID and PW), Host authentication (MAC address); HTTPS encryption; IEEE 802.1x port-based network access control; IP address filtering
System Integration	
Alarm Input	7-ch alarm input
Alarm Output	2-ch alarm output
Alarm Linkage	Alarm actions, such as Preset, Patrol Scan, Pattern Scan, Memory Card Video Record, Trigger Recording, Notify Surveillance Center, Upload to FTP/Memory Card/NAS, Send Email, etc.
Audio Input	1-ch audio input
Audio Output	1-ch audio output
Network Interface	1 RJ45 10 M/100 M Ethernet Interface; Hi-PoE
CVBS	Support
RS-485	HIKVISION, Pelco-P, Pelco-D, self-adaptive
Storage	Built-in memory card slot, support Micro SD/SDHC/SDXC, up to 256 GB; NAS (NPS, SMB/CIFS), ANR
API	Open-ended, support ONVIF, and CGI, support HIKVISION SDK and Third-Party Management Platform
Client	iVMS-4200, iVMS-4500, iVMS-5200, Hik-Connect
Web Browser	IE7+, Chrome18-42, Firefox5.0+, Safari5.02+
General	
Power	24 VAC (Max. 60 W) Hi-PoE (Max. 50 W)
Working Temperature	-40°C to 65°C (-40°F to 149°F) (Outdoor) -10°C to 50°C (14°F to 122°F) (Indoor)
Working Humidity	≤ 90%
Protection Level	IP66 Standard (Outdoor), TVS 6,000V Lightning Protection, Surge Protection and Voltage Transient Protection
Dimensions	Φ 220 mm × 302 mm (Φ 8.66" × 11.89") (Outdoor) Φ 245.1 mm × 239 mm (Φ 9.65" × 9.41") (Indoor)
Weight	Approx. 4 kg (8.82 lb) (Outdoor) Approx. 3.4 kg (7.50 lb) (Indoor)

**Order Model**

DS-2DF5225X-AEL, 24 VAC &amp; Hi-PoE (Outdoor)

DS-2DF5225X-AE3, 24 VAC &amp; Hi-PoE (Indoor)

**Dimensions**

Outdoor Speed Dome

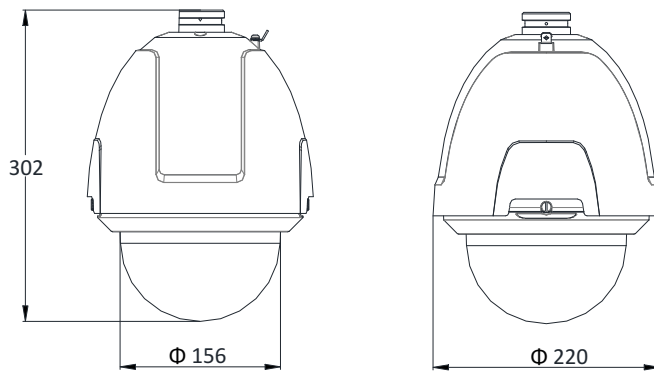



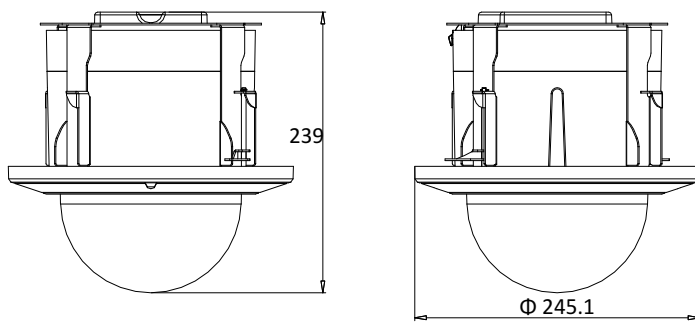









Indoor Speed Dome



Unit: mm

## Accessories

	DS-1604ZJ	Wall Mounting Bracket
	DS-1604ZJ-box	Wall Mounting Bracket with Junction Box
	DS-1604ZJ-box-pole	Vertical Pole Mounting Bracket with Junction Box
	DS-1604ZJ-box-corner	Wall Mounting Bracket with Junction Box
	DS-1660ZJ	Parapet Wall Mounting Bracket
	DS-1619ZJ	Gooseneck Mounting Bracket
	DS-1661ZJ	Pendant Mounting Bracket
	DS-1662ZJ	Pendant Mounting Bracket
	DS-1663ZJ	Ceiling Mounting Bracket
	DS-1667ZJ	Extendable Pole for Pendant Mounting Bracket
	DS-1673ZJ	Horizontal Pole Mounting Bracket
	DS-1682ZJ	Extendable Pole for Pendant Mounting Bracket

**Headquarters**  
 No.55 Qianmo Road, Binjiang District,  
 Hangzhou 310051, China  
 T +86-571-8807-5998  
[overseasbusiness@hikvision.com](mailto:overseasbusiness@hikvision.com)

**Hikvision USA**  
 T +1-909-895-0400  
[sales.usa@hikvision.com](mailto:sales.usa@hikvision.com)

**Hikvision Europe**  
 T +31-23-55-42-770  
[info.eu@hikvision.com](mailto:info.eu@hikvision.com)

**Hikvision Middle East**  
 T +971-4-8816086  
[salesme@hikvision.com](mailto:salesme@hikvision.com)

**Hikvision Russia**  
 T +7-495-669-67-99  
[saleru@hikvision.com](mailto:saleru@hikvision.com)

**Hikvision India**  
 T +91-22-28469900  
[sales@pramahikvision.com](mailto:sales@pramahikvision.com)

**Hikvision Italy**  
 T +39-0438-6902  
[info.it@hikvision.com](mailto:info.it@hikvision.com)

**Hikvision France**  
 T +33(0)1-85-330-450  
[info.fr@hikvision.com](mailto:info.fr@hikvision.com)

**Hikvision Spain**  
 T +34-91-737-16-55  
[info.es@hikvision.com](mailto:info.es@hikvision.com)

**Hikvision Poland**  
 T +48-22-460-01-50  
[poland@hikvision.com](mailto:poland@hikvision.com)

**Hikvision UK**  
 T +01628-902140  
[support.uk@hikvision.com](mailto:support.uk@hikvision.com)

**Hikvision Singapore**  
 T +65-6684-4718  
[sg@hikvision.com](mailto:sg@hikvision.com)

**Hikvision Oceania**  
 T +61-2-8599-4233  
[salesau@hikvision.com](mailto:salesau@hikvision.com)

**Hikvision Canada**  
 T +1-909-895-0400  
[sales.usa@hikvision.com](mailto:sales.usa@hikvision.com)

**Hikvision Korea**  
 T +82-31-731-8841  
[sales.korea@hikvision.com](mailto:sales.korea@hikvision.com)

**Hikvision Brazil**  
 T +55 11 3318-0050  
[Latam.support@hikvision.com](mailto:Latam.support@hikvision.com)

**Hikvision South Africa**  
 Tel: +27 (10) 0351172  
[sale.africa@hikvision.com](mailto:sale.africa@hikvision.com)

**Hikvision Hong Kong**  
 T +852-2151-1761