

11 Megapixel Color High Definition Professional IP Camera

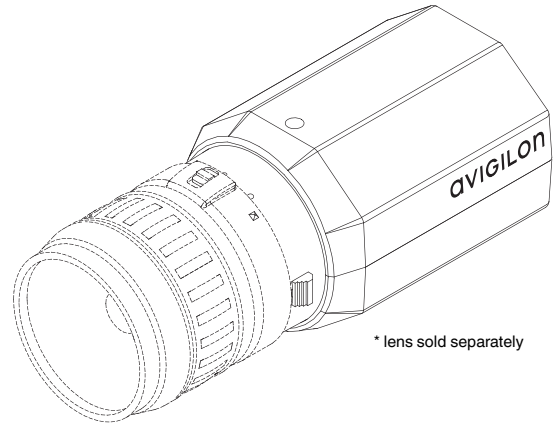

Description

The Avigilon 11 megapixel color high definition professional IP camera is a high sensitivity, wide dynamic range, progressive scan CCD camera designed for the most demanding surveillance applications. It transmits images over 100BASE-TX using advanced JPEG2000 progressive compression technology to achieve the lowest network bandwidth and most efficient image storage in the industry while maintaining unsurpassed image quality.

The camera's advanced image acquisition system automatically adjusts the exposure time and the iris to ensure all available evidence is captured throughout the full range of day and nighttime scenes. The camera has an EF lens mount that is compatible with a wide selection of Canon® lenses.

The camera seamlessly integrates with Avigilon Control Center NVMS and High Definition NVRs using standard network equipment creating a network based surveillance solution with unmatched performance, ease of use, and ease of installation. Camera power is provided by either Power over Ethernet, 12 VDC, or 24 VAC.

Features

- 11 megapixel progressive scan CCD sensor
- Unsurpassed image quality
- 5 images per second at full resolution and 10 images per second at 4000 x 480
- 66 dB true dynamic range
- 0.1 lux minimum illumination
- Lossless JPEG2000 compression
- 35 mm optical format
- Automatic exposure control and iris control
- Software focus control
- Compatible with a wide selection of Canon® EF mount lenses
- Power over Ethernet, 24 VAC or 12 VDC power input
- External I/O and RS-485 interface

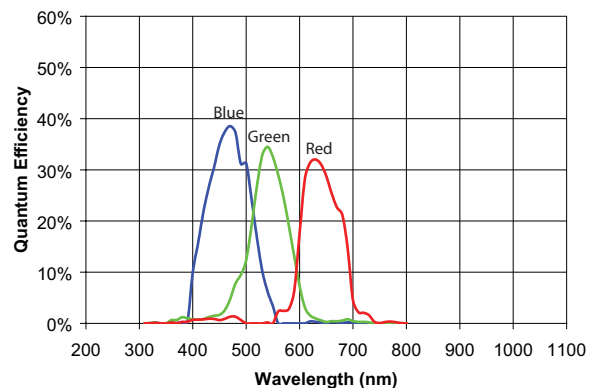

Specifications

Camera

Image Sensor	35 mm progressive scan interline transfer CCD
Active Pixels	4000 (H) x 2672 (V)
Imaging Area	37.3 mm (H) x 25.7 mm (V) 1.468" (H) x 1.012" (V)
Minimum Illumination	0.1 lux (at F1.4)
Dynamic Range	66 dB
Lens Mount	EF (SLR-style bayonet)
Image Compression Method	JPEG2000
Image Rate	5 (at full resolution) 10 (at 4000 x 480)
Resolution Windowing	Down to 640 x 480 Window
Motion Detection	Selectable sensitivity and threshold
Electronic Shutter Control	Automatic, Manual (2 to 1/60000 sec)
Iris Control	Automatic, Manual
Focus Control	Automatic, Manual
Flicker Control	50 Hz, 60 Hz
White Balance	Automatic, Manual
Backlight Compensation	Automatic
Privacy Zones	Up to 4 zones
External I/O Terminals	Alarm In, Alarm Out, RS-485

Network

Network	100BASE-TX
Cabling Type	CAT5
Connector	RJ-45
Security	SSL
Protocol	UDP, TCP, SOAP, DHCP, Zeroconf

Mechanical

Dimensions (LxWxH)	120 mm x 79 mm x 74 mm 4.7" x 3.1" x 2.9"
Weight	1.15 kg (2.5 lbs) without lens
Camera Mount	1/4" UNC-20 (top and bottom)

Electrical

Power Source	VDC: 12-24 V VAC: 24 V PoE: IEEE802.3af Class 3 compliant
Power Consumption	9 W
Power Connector	2-pin terminal block

Environmental

Operating Temperature	-10 °C to +50 °C (14 °F to 122 °F)
Storage Temperature	-10 °C to +70 °C (14 °F to 158 °F)
Humidity	20 - 80% Relative humidity (non-condensing)

Certifications

CE, Class A
FCC, Class A
UL/cUL Listed

Ordering Information

11MP-HD-PRO-C	11 Megapixel Color High Definition Professional IP Camera
---------------	---

Outline Dimensions

