

6-port Full Gigabit Industrial PoE Fiber Switch

- 4*10/100/1000Base-T RJ45 ports and 2*1000Base-X uplink SFP ports, port 1-4 can support PoE.
- Dual uplink SFP fiber port , long-distance transmission
- Dual power supply input , DC input: 48V-57V, 6KV port lightning protection,
- -40°C—+80°C operation temperature
- Large cache military-level master chip configuration, IP40 protection aluminum alloy case, 5-year warranty.



OVERVIEW

The ONV-IPS33064PF series is a full gigabit industrial PoE fiber switch independently developed by ONV. It has 4*10/100/1000Base-T RJ45 ports and 2*1000Base-X SFP fiber slot ports. Port 1-4 can support IEEE 802.3af/at PoE standard, single-port PoE power up to 30W, and the maximum PoE output power of the host is 60W (at-120W). As a PoE power supply device, it can automatically detect and recognize the power receiving equipment that meets the standard and supply power through the network cable. It can supply power to PoE terminal device such as wireless AP, IP camera, industrial sensor through the network cable, and meet the network environment that needs high-density PoE power supply. It is suitable for intelligent transportation, rail transit, power industry, mining, petroleum, sea transportation. Industrial scenes such as metallurgy and green energy construction form a cost-effective, stable and reliable communication network.

FEATURE

■ Gigabit Ethernet port access, uplink gigabit dual SFP port

- ◇ Uplink gigabit dual SFP fiber ports, easy to achieve high bandwidth and long-distance transmission.
- ◇ Dual SFP fiber ports can cascade, chain, compatible with SFP module connection.

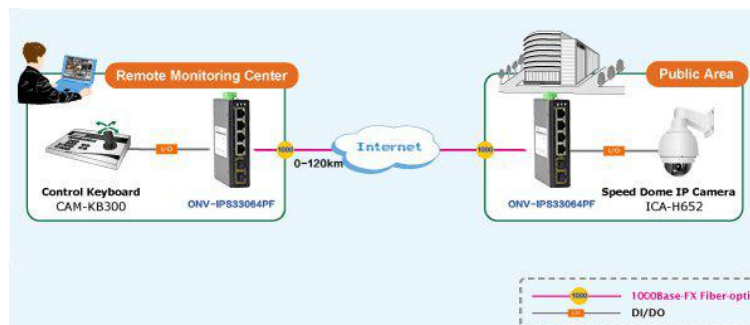

■ Powerful port lightning protection, wide voltage input

- ◇ Contact discharge 8KV, air discharge 15KV; port lightning protection common-mode 4KV, differential mode 2KV;
- ◇ Industrial dual power input
- ◇ DC INPUT: 48V-57V, non-PoE DC INPUT: 12-48V.

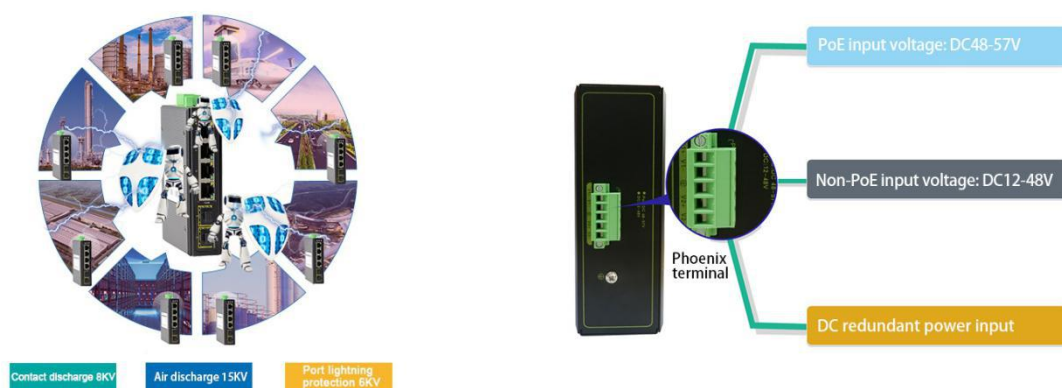

■ Intelligent PoE power supply

- ◇ 4*10/100/1000Base-T RJ45 ports, meeting the needs of security monitoring, teleconferencing system, wireless coverage, and other scenarios.
- ◇ IEEE 802.3af/at PoE standard, without damaging non-PoE devices.

- ◇ Priority system for PoE port, it will supply power to the high priority level port first when the power budget is insufficient and avoid overwork of the device.

■ **Stable and reliable**

- ◇ Low power consumption, No fan, aluminum casing.
- ◇ CCC, CE, FCC, RoHS.
- ◇ The user-friendly panel, it can show the device status through the LED indicator of PWR, SYS, Link, L/A, PoE.

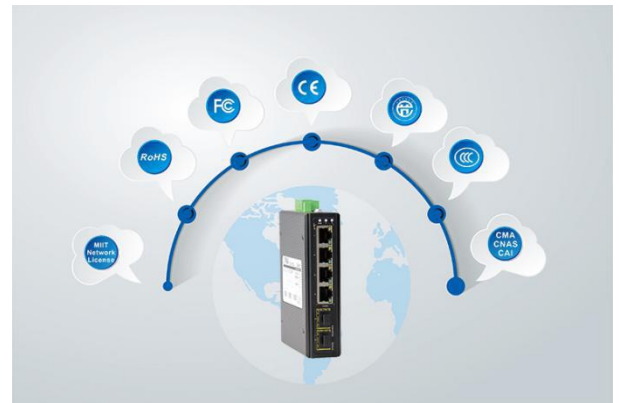
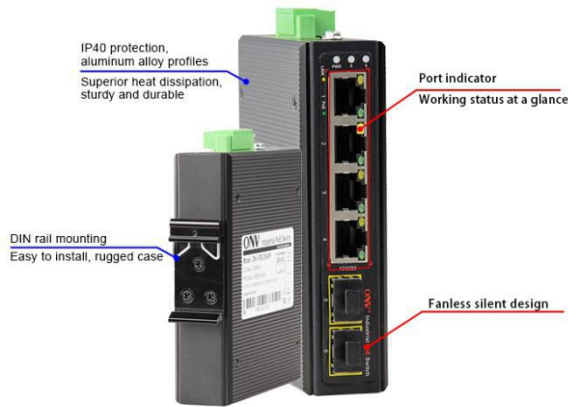

TECHNICAL SPECIFICATION

Model	ONV-IPS33064PF	ONV-IPS33064PF-at
Interface Characteristics		
Fixed Port	4*10/100/1000Base-T PoE ports (Data/Power) 2*1000Base-X uplink SFP slot ports(Data) 2 set of V+, V- redundant DC power interface (5P Phoenix terminal)	
Ethernet Port	Port 1-4 support 10/100Base-TX, auto-sensing, Full/half duplex MDI/MDI-X self-adaption	
Twisted Pair Transmission	10BASE-T: Cat3,4,5 UTP(≤100 meter) 100BASE-TX: Cat5 or later UTP(≤100 meter) 1000BASE-T: Cat5e or later UTP(≤100 meter)	

Fiber Port	Gigabit SFP optical fiber port, default matching optical modules (optional order single-mode / multi-mode, single fiber / dual fiber optical module. LC)	
Optical Cable	Multimode: 850nm 0 ~ 550M, singlemode: 1310nm 0 ~ 40KM, 1550nm 0 ~ 120KM.	
Chip Parameter		
Network Protocol	IEEE802.3 10BASE-T, IEEE802.3i 10Base-T, IEEE802.3u 100Base-TX, IEEE802.3ab 1000Base-T IEEE802.3z 1000Base-X, IEEE802.3x	
Forwarding Mode	Store and Forward(Full Wire Speed)	
Switching Capacity	16Gbps	
Forwarding Rate@64byte	8.93Mpps	
MAC	8K	
Buffer Memory	2M	
Jumbo Frame	9.2K	
LED Indicator	Power: PWR (green), network ;Link, (yellow), POE: PoE (green), Fiber port : 5/6 (green)	
PoE & Power		
PoE Port	Port 1 to 4 IEEE802.3af/at @ POE	
Power Supply Pin	Default :1/2 (+), 3/6 (-), optional:4/5 (+), 7/8 (-)	
Max Power Per Port	30W; IEEE802.3af/at	
Total PWR / Input Voltage	60W/48VDC	120W/48VDC
Power Consumption	Standby:<4W;Full load:<60W	Standby:<5W;Full load:<120W
Power Supply	No, optional 48V/60W or 48V/120W industrial power supply	
Working Voltage	48-57VDC; 5P industrial Phoenix terminal, support anti-reverse protection.	

Physical Parameter	
Operation TEMP / Humidity	-40~+80°C;5%~90% RH Non condensing
Storage TEMP / Humidity	-40~+85°C;5%~95% RH Non condensing
Dimension (L*W*H)	119*100*30mm
Net /Gross Weight	<0.5kg / <0.7 kg
Installation	Desktop, DIN rail
Certification & Warranty	
Lightning protection / protection level	<p>Lightning protection: 6KV 8/20us; Protection level: IP40</p> <p>IEC61000-4-2(ESD):±8kV contact discharge,±15kV air discharge</p> <p>IEC61000-4-3(RS):10V/m(80~1000MHz)</p> <p>IEC61000-4-4(EFT): power cable:±4kV; data cable:±2kV</p> <p>IEC61000-4-5(Surge):power cable:CM±4kV/DM±2kV; data cable:±4kV</p> <p>IEC61000-4-6(radio frequency transmission):10V(150kHz~80MHz)</p> <p>IEC61000-4-8(power frequency magnetic field):100A/m;1000A/m ,1s to 3s</p> <p>IEC61000-4-9(pulsed magnet field):1000A/m</p> <p>IEC61000-4-10(damped oscillation):30A/m 1MHz</p> <p>IEC61000-4-12/18(shockwave):CM 2.5kV,DM 1kV</p> <p>IEC61000-4-16(common-mode transmission):30V; 300V,1s</p> <p>FCC Part 15/CISPR22(EN55022):Class A</p> <p>IEC61000-6-2(Common Industrial Standard)</p>
Mechanical Properties	<p>IEC60068-2-6 (anti vibration)</p> <p>IEC60068-2-27 (anti shock)</p> <p>IEC60068-2-32 (free fall)</p>
Certification	CCC;CE mark, commercial; CE/LVD EN60950;FCC Part 15 Class B; RoHS;
Warranty	5 years , lifelong maintenance.

DIMENSION

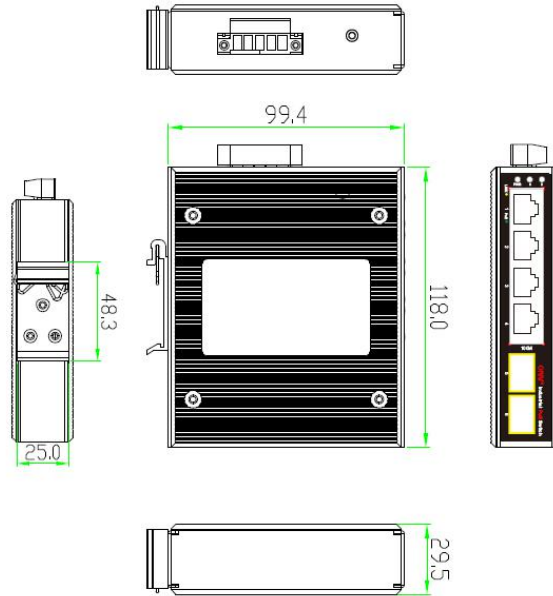

APPLICATION

1. Network Topology (Single Application)

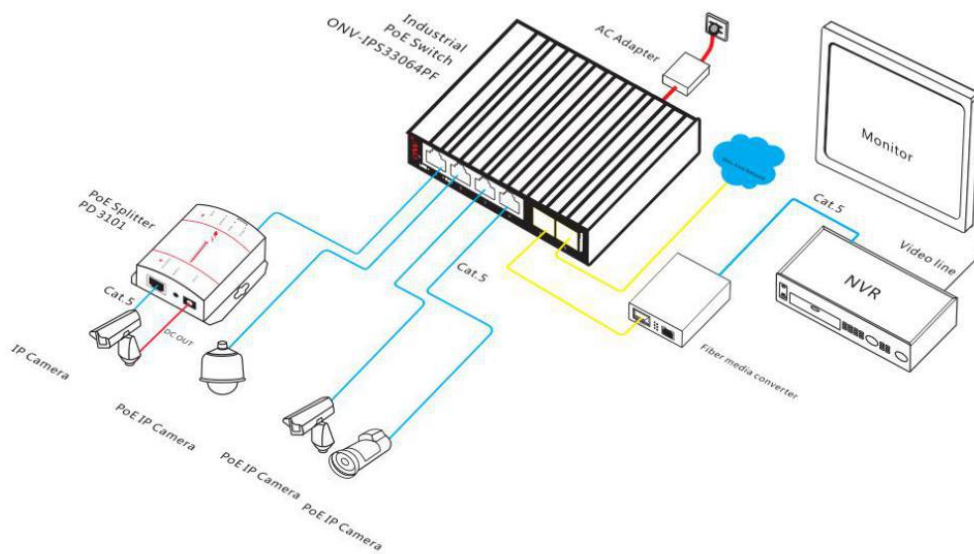

(Ethernet Ring Network Application)

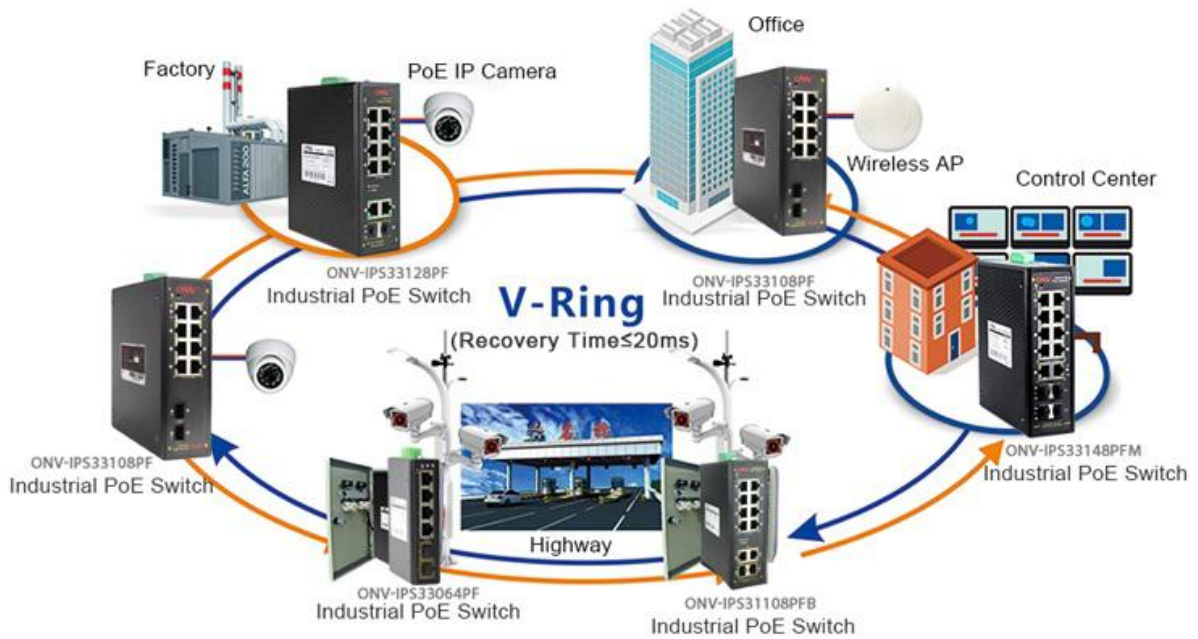

2. Product overview

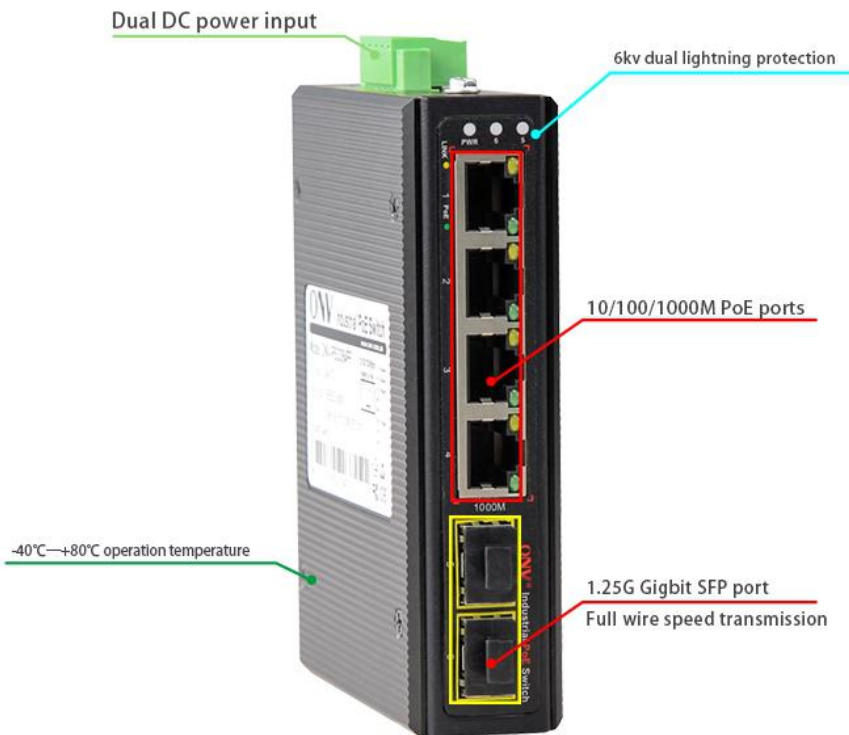

ORDERING INFORMATION

Model	Description	Recommended Power Supply
ONV-IPS33064PF	Unmanaged industrial PoE fiber switch with 4*10/100/1000M RJ45 ports and 2*1000M SFP slot ports,	60W
ONV-IPS33064PF-at	Port 1-4 can support IEEE802.3af/at PoE standard. Support dual DC power supply input and DIN rail mounting.	120W

Note: Industrial PoE fiber switch does not match the optical module and power supply.

PACKING LIST

	CONTENT	QTY	UNIT
PACKING LIST	6-port full gigabit industrial PoE fiber switch	1	SET
	User Guide	1	PC
	Warranty Card	1	PC

OPTICAL MODULE INFORMATION

Product	Model	Description	Unit
1.25G Fiber Module	ONV-2630	SFP optical module, 1.25G, multi mode dual fiber 850nm, transmission distance: 550m, LC interface, support DDM function, support hot plug and pull.	PC
	ONV-2632	SFP optical module, 1.25G, single-mode dual fiber 1310nm, transmission distance: 20km, LC interface,	PC

		support DDM function, support hot plug and pull.	
	ONV-2612-T	SFP optical module, 1.25G, single-mode single fiber TX1310nm/RX1550nm, transmission distance: 20km, LC interface, support DDM function, support hot plug and pull.	PC
	ONV-2613-R	SFP optical module, 1.25G, single-mode single fiber TX1550nm/RX1310nm, transmission distance: 20km, LC interface, support DDM function, support hot plug and pull.	PC
	2612-T-G	Industrial SFP optical module, 1.25G, single-mode single fiber TX1310nm/RX1550nm, transmission distance: 20km, LC interface, support DDM function, support hot plug and pull.	PC
	2613-R-G	Industrial SFP optical module, 1.25G, single-mode single fiber TX1550nm/RX1310nm, transmission distance: 20km, LC interface, support DDM function, support hot plug and pull.	PC
	ONV-2612-T-S C	SFP optical module, 1.25G, single-mode single fiber TX1310nm/RX1550nm, transmission distance: 20km, SC interface, support DDM function, support hot plug and pull.	PC
	ONV-2613-R-S C	SFP optical module, 1.25G, single-mode single fiber TX1550nm/RX1310nm, transmission distance: 20km, SC interface, support DDM function, support hot plug and pull.	PC
Power Module	ONV-2633	1.25G SFP optical module transfers to 10/100/1000M RJ45 port.	PC

POWER SUPPLY SELECTION TABLE

Product	Model	Description	Unit
65W Desktop Power Adaptor	GWS-AP65-52	Desktop tape 65W single set of output power adapter; Input Voltage:AC 100V~240V 50-60Hz,1.1A Output Voltage:DC 52V 1.25A Operation Temperature:-20℃—+65℃	PC
110W Desktop Power Adaptor	GWS-AP110-52	Desktop tape 110W single set of output power adapter; Input Voltage:AC 100V~240V 50-60Hz,2.0A Output Voltage:DC 52V 2.0A Operation Temperature:-20℃—+65℃	PC
60W DIN Rail Industrial Power Supply	GWS-DP60-48	Din Rail type 60W single set of output power supply; Input Voltage:AC 100V~240V 50-60Hz,1A Output Voltage:DC 48V 1.25A Operation Temperature:-40℃—+70℃	PC
120W DIN Rail Industrial Power Supply	GWS-DP120-48	Din Rail type 120W single set of output power supply; Input Voltage:AC 100V~240V 50-60Hz,1.5A Output Voltage:DC 48V 2.5A Operation Temperature:-40℃—+70℃	PC

RELATED PRODUCT

Model	Description
ONV-IPS33021PF	Unmanaged industrial PoE fiber switch with 1*10/100/1000M RJ45 port and 1*1000M SFP slot port, Port 1 can support IEEE802.3af/at PoE standard. Support dual DC power supply input and DIN rail mounting.
ONV-IPS33032PF	Unmanaged industrial PoE fiber switch with 2*10/100/1000M RJ45 ports and 1*1000M SFP slot port, Port 1-2 can support IEEE802.3af/at PoE standard. Support dual DC power supply input and DIN rail mounting.
ONV-IPS33042PF	Unmanaged industrial PoE fiber switch with 2*10/100/1000M RJ45 ports and 2*1000M SFP slot ports, Port 1-2 can support IEEE802.3af/at PoE standard. Support dual DC power supply input and DIN rail mounting.
ONV-IPS33054PF	Unmanaged industrial PoE fiber switch with 4*10/100/1000M RJ45 ports and 1*1000M SFP slot port, Port 1-4 can support IEEE802.3af/at PoE standard. Support dual DC power supply input and DIN rail mounting.
ONV-IPS33064PFG	Unmanaged industrial PoE fiber switch with 5*10/100/1000M RJ45 ports and 1*1000M SFP slot port, Port 1-4 can support IEEE802.3af/at PoE standard. Support dual DC power supply input and DIN rail mounting.

CONTACT US

ONV Optical Network Video Technologies (Shenzhen) Co., Ltd.

Tel: 0086-755-33376606

Fax: 0086-755-33376608

Email: onv@onv.com.cn

Website: www.onvcom.com

Zip: 518000

Headquarter Address: Room 1003, Block D, Terra Building, Futian District, Shenzhen, China

Factory Address: The 4-6th Floor, No. 59, HuaNing Road, Xinwei Community, Dalang Street,
Longhua District, Shenzhen, China

